

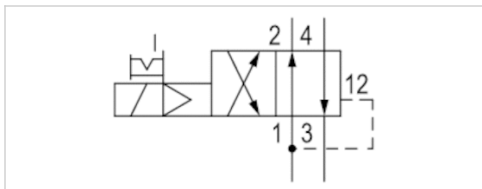







4/2-directional valve, Series 840

- 4/2
- $Q_n = 200$ l/min
- Pilot valve width : 22.5 mm
- Pipe connection
- Compressed air connection output : $\varnothing 6 \times 1$
- Electrical connection : Plug, EN 175301-803, form C
- Manual override : with detent
- single solenoid
- with air spring return
- Pilot : Internal



Version	Diaphragm poppet valve
Activation	Electrically
Pilot	Internal
Sealing principle	Soft sealing
Working pressure min./max.	1,5 ... 10 bar
Control pressure min./max.	1,5 ... 10 bar
Ambient temperature min./max.	-15 ... 50 °C
Medium temperature min./max.	-15 ... 50 °C
Medium	Compressed air
Max. particle size	50 μm
Oil content of compressed air	0 ... 1 mg/m ³
Nominal flow Q_n	200 l/min
Connector standard	EN 175301-803, form C
Protection class with connection	IP65
Reverse polarity protection	Protected against polarity reversal
Duty cycle	100 %
Typ. switch-on time	12 ms
Typ. switch-off time	12 ms
Mounting on manifold strip	PRS strip
Weight	See table below

Technical data

Part No.	MO	Compressed air connection	
		Input	Output
5728400410		Ø 6x1	Ø 6x1
5728400420		Ø 6x1	Ø 6x1
5728400620		Ø 6x1	Ø 6x1
5728405420		Ø 6x1	Ø 6x1
5728405470		Ø 6x1	Ø 6x1
5728405480		Ø 6x1	Ø 6x1
5728405680		Ø 6x1	Ø 6x1

Part No.	Compressed air connection	
	Exhaust	Pilot Exhaust
5728400410	Ø 6x1	Ø 4,5
5728400420	Ø 6x1	Ø 4,5
5728400620	Ø 6x1	Ø 4,5
5728405420	Ø 6x1	Ø 4,5
5728405470	Ø 6x1	Ø 4,5
5728405480	Ø 6x1	Ø 4,5
5728405680	Ø 6x1	Ø 4,5

Part No.	Operational voltage		Operational voltage
	DC	AC 50 Hz	AC 60 Hz
5728400410	12 V	-	-
5728400420	24 V	-	-
5728400620	24 V	-	-
5728405420	-	24 V	24 V
5728405470	-	110 V	110 V
5728405480	-	230 V	230 V
5728405680	-	230 V	230 V

Part No.	Voltage tolerance			Power consumption
	DC	AC 50 Hz	AC 60 Hz	DC
5728400410	-10% / +10%	-	-	1,6 W
5728400420	-10% / +10%	-	-	1,6 W
5728400620	-10% / +10%	-	-	1,6 W
5728405420	-	-10% / +15%	-10% / +15%	-
5728405470	-	-10% / +15%	-10% / +15%	-
5728405480	-	-10% / +15%	-10% / +15%	-
5728405680	-	-10% / +15%	-10% / +15%	-

Part No.	Holding power		Switch-on power	
	AC 50 Hz	AC 60 Hz	AC 50 Hz	AC 60 Hz
5728400410	-	-	-	-
5728400420	-	-	-	-
5728400620	-	-	-	-
5728405420	2,2 VA	1,9 VA	3 VA	2,6 VA
5728405470	2,2 VA	1,9 VA	3,1 VA	2,6 VA
5728405480	2,3 VA	2 VA	3,2 VA	2,8 VA

Part No.	Holding power	Holding power	Switch-on power	Switch-on power
	AC 50 Hz	AC 60 Hz	AC 50 Hz	AC 60 Hz
5728405680	2,5 VA	2,2 VA	3,5 VA	3 VA

Part No.	LED status display	Weight
5728400410	-	0,096 kg
5728400420	-	0,097 kg
5728400620	Red	0,097 kg
5728405420	-	0,095 kg
5728405470	-	0,096 kg
5728405480	-	0,095 kg
5728405680	Red	0,095 kg

Nominal flow Q_n at 6 bar and $\Delta p = 1$ bar, MO = Manual override

Technical information

The min. control pressure must be adhered to, since otherwise faulty switching and valve failure may result!

The pressure dew point must be at least 15 °C under ambient and medium temperature and may not exceed 3 °C .

The oil content of compressed air must remain constant during the life cycle.

Use only the approved oils from AVENTICS. Further information can be found in the "Technical information" document (available in the MediaCentre).

Versions with voltage of less than 50 V DC do not have a protective ground.

The maximum operating pressure depends on the ambient temperature. The following values are applicable - 15 °C ... 50 °C =

Operating pressure 1.5 bar ... 8 bar possible

- 15 °C ... 40 °C = Operating pressure 1.5 bar ... 10 bar possible.

Technical information

Material	
Housing	Polyoxymethylene
Seals	Acrylonitrile butadiene rubber

Dimensions

Dimensions

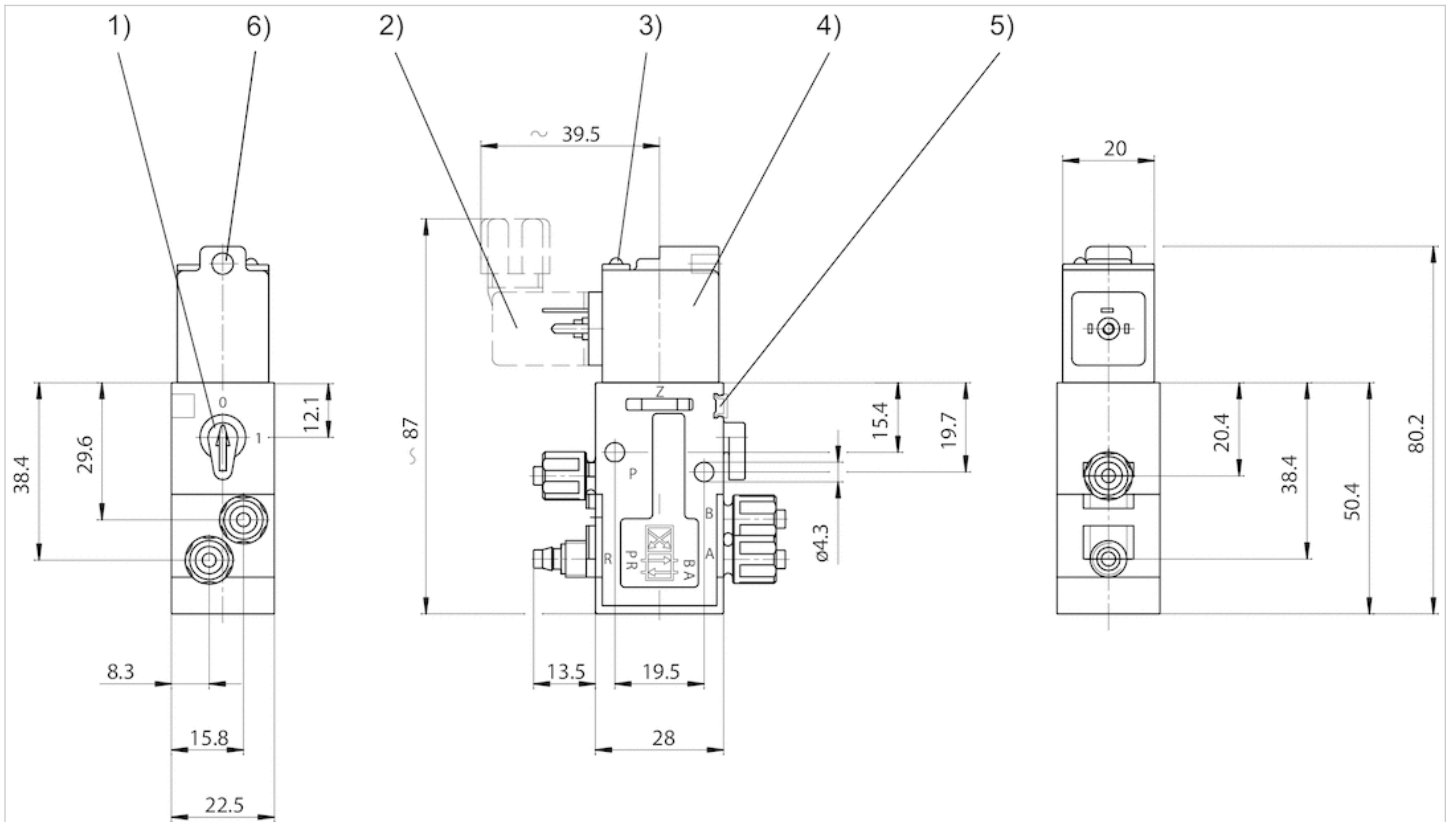

1) Manual override 2) Valve plug connector 3) LED display 4) Coil can be rotated at 180° intervals 5) Mounting space for name plate 6) Hole for M5 fitting or silencer \varnothing 4.5 mm